

PeliExterior[®] Compact

HPL Exterior
Compact Panels
HPL Kompakt
Dış Cephe Panelleri

Solid / Düz
Wood / Ahşap
Stone-Marble / Taş Mermer
Digital / Dijital

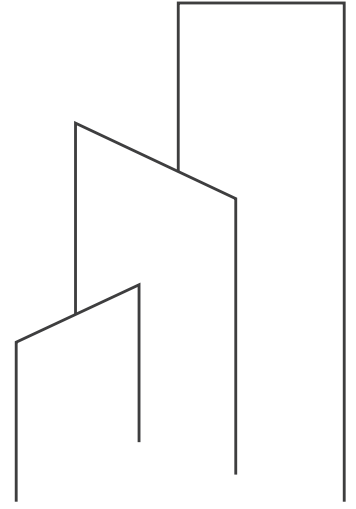

Peli[®]





PeliExterior[®] Compact

PeliExterior, with ISO 9001 TÜV SÜD guarantee, is being produced according to EN 438-6/7, the required Standard for high pressure exterior laminate applications.

PeliExterior has a surface property of anti-dirt, anti-bacteria, anti-fading with its nanotechnology surface form.

PeliExterior ISO 9001 TÜV SÜD garantisıyla ve yüksek basınçlı harici laminat uygulamaları standardı olan EN 438-6/7 'ye uygun olarak üretilmektedir. PeliExterior kirlenmeyen ve bakteri tutmayan, solmaya dayanıklı ve nano teknolojik bir yüzeye sahiptir.



PeliExterior® Compact

Solid Colors
Düz Renkler

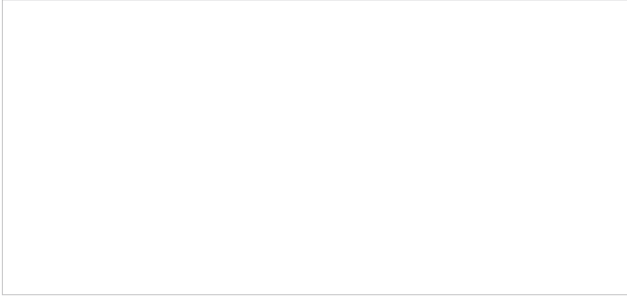
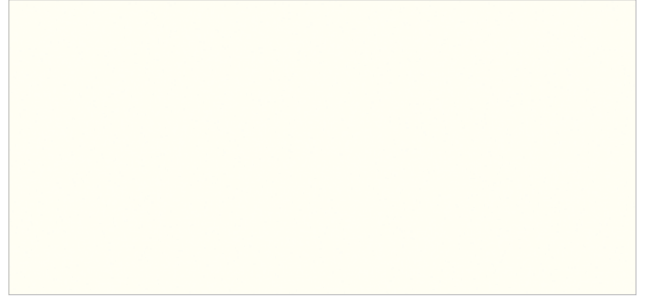
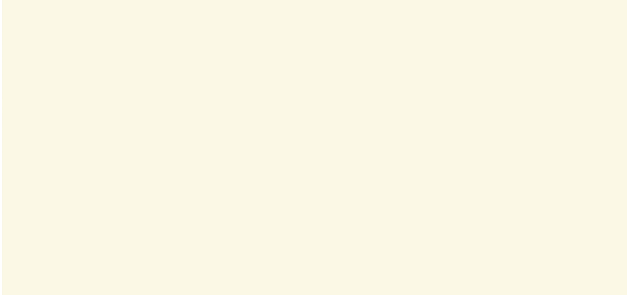
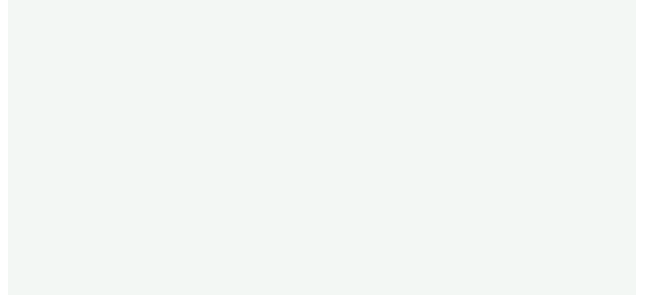
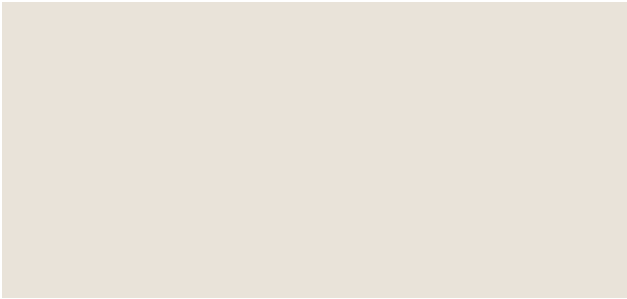
**1148** - Ultra Beyaz**1100** - Süper Beyaz**1167** - Beyaz Bulut**1172** - Unicorn**1137** - Vezir Krem**1151** - Yeni Vanilya**1171** - Latte**1136** - Vezir Gri**1123** - Gri**1174** - Newyork

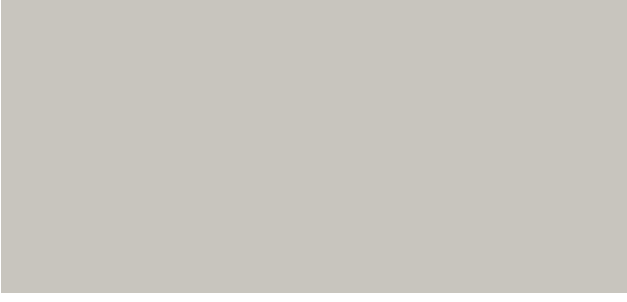

1186 - Nil Beji

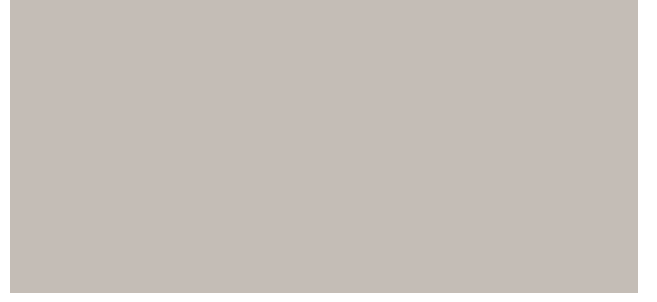

1187 - Dolunay

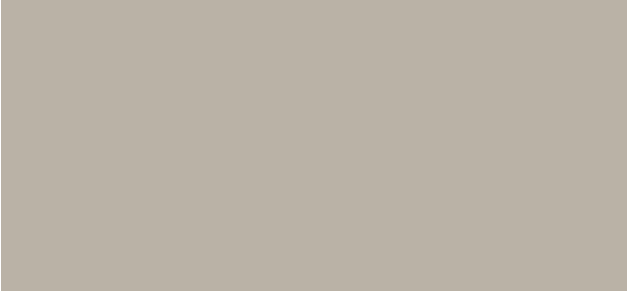

1185 - Kum Taşı



1188 - Kaşmir Dafne

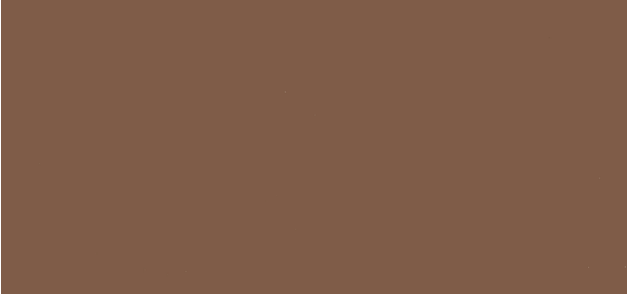

1164 - Rome



1147 - Sumela

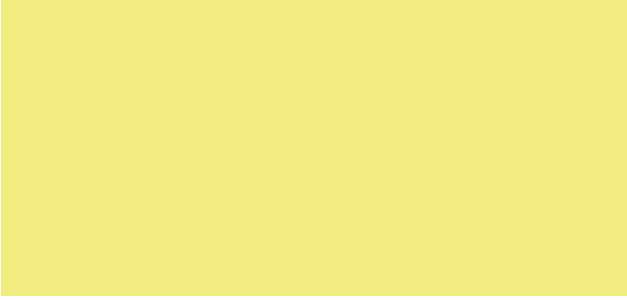

1181 - Limoni

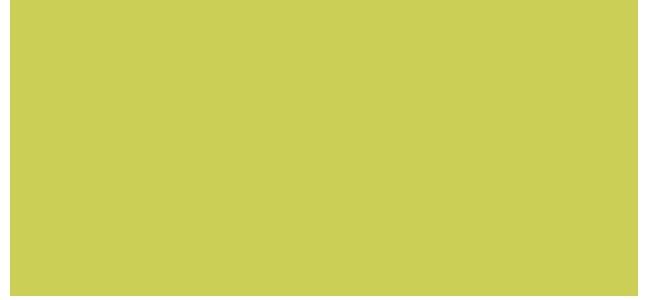

1179 - Lime



1180 - Olive



1166 - Daphene





1129 - Papatya Sarı



1160 - Arch



1159 - Emel



1138 - Turuncu



1175 - Ruj



1146 - Açık Kırmızı

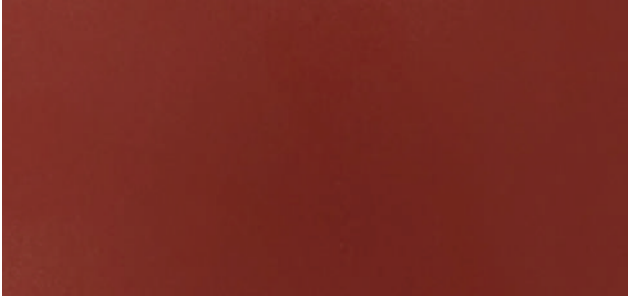

1153 - Bordo



1125 - Gök Mavi



1113 - Okyanus Mavi



1176 - Lagun



1157 - Ocean



1128 - Gece Mavi

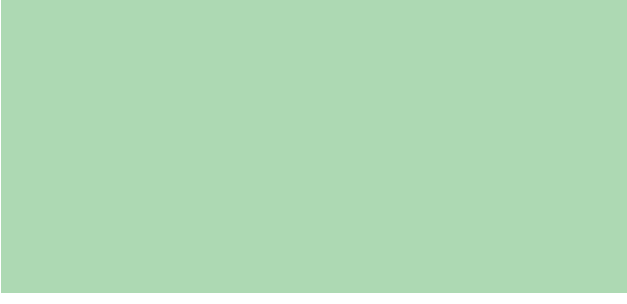

1183 - Mint Yeşil



1139 - Çim Yeşili



1163 - Melody



1158 - Tiffany

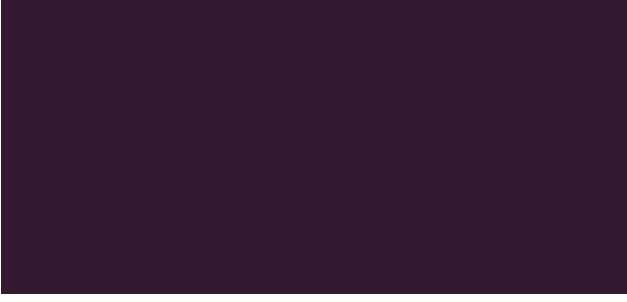

1177 - Viola

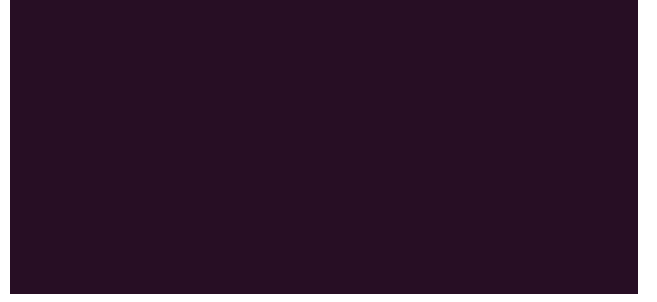

1149 - Purple

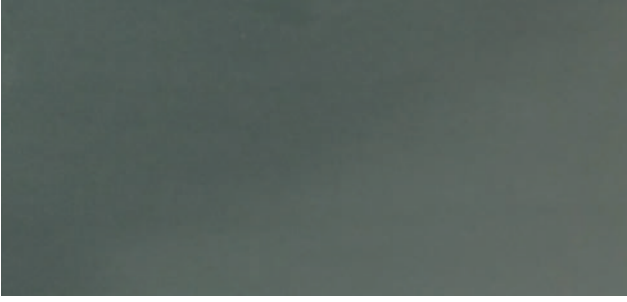

1154 - Verdure



1165 - School



1601 - Gri Antrasit

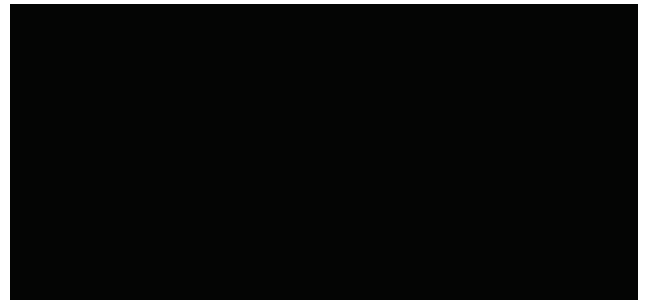

1102 - Siyah



PeliExterior[®]
Compact

Wooden
Patterns
Ahşap
Desenler





2215 - Akçaağaç



2703 - American Maple



2746 - Amber Meşe



2725 - Real Teak



2701 - Elm



2742 - Siam Teak



2266 - Light Piner Oak



2223 - Otona Oak



2220 - Sonoma Oak



2775 - Vermont Elm



2783 - Dante



2793 - Light Canyon Oak



2798 - Light Gabi



2794 - Brown Canyon Oak



2748 - Abs Teak

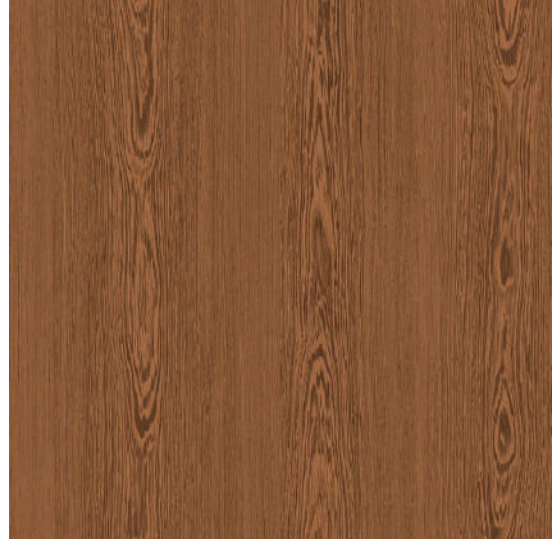

2299 - New Golden Oak



2729 - Novacento



2272 - Açık Ceviz





2252 - Kızıl Alder



2273 - Erik



2717 - Goa



2744 - Elma

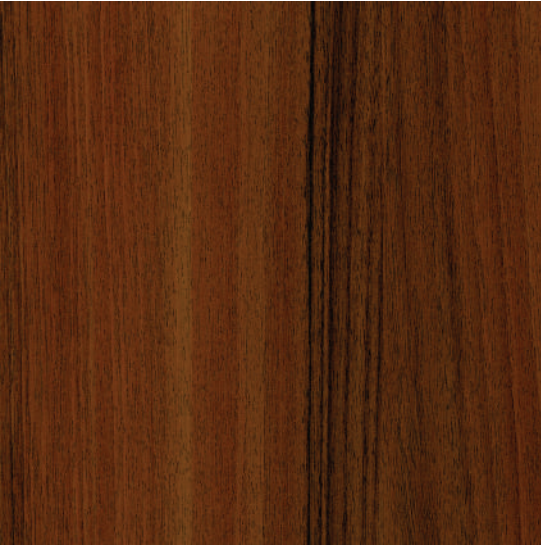

2229 - Freze Ceviz



2245 - Samoa Teak



2728 - Amerikan Ceviz

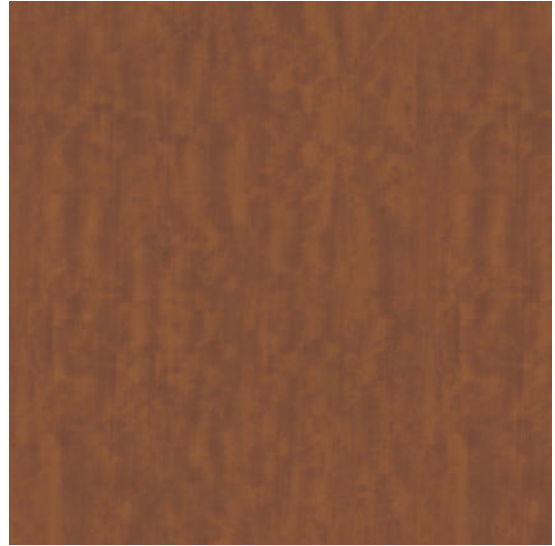

2721 - Delhi Oak



2772 - Gabi



2723 - Avrupa Abanoz



2297 - Erca Chesnut

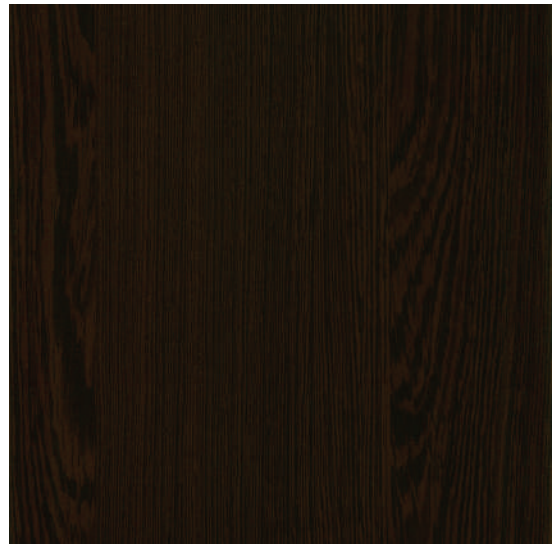

2227 - Wenge



2731 - Saruhan Teak



2779 - Alp Oak



2730 - Marmara Ceviz



PeliExterior[®]
Compact

Stone/Marble
Patterns

Taş/Mermer
Desenler





3433 - Rita



3432 - Fog



3469 - Light Basalt



3457 - Rock



3463 - Grey Sand Stone

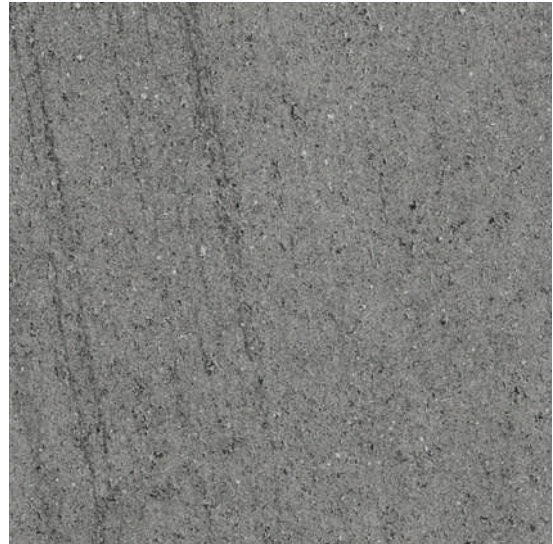

3468 - Grey Volcano

**3434** - Fossil**3471** - Dark Basalt**3456** - Dark Oxid**3467** - Raw Metal**3464** - Red Rusty**3440** - Oxid

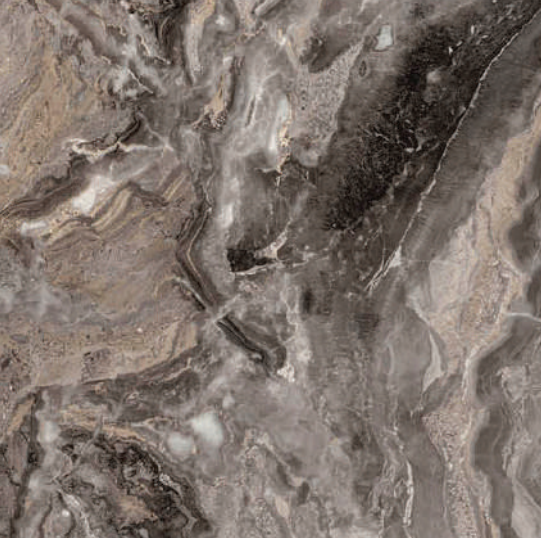

3446 - Sand Stone



3470 - Formigo



3312 - Opuz





PeliExterior[®]
Compact

Technic
Teknik

PeliExterior[®] Compact

PeliExterior, combining the warmth of wood with the compact laminate, equalizes the facade life with the building's lifespan. Low density and flexibility of PeliExterior are the major advantages against all other facade applications for the building's earthquake safety. Wide variety of designs and colors enable an exceptional appearance of facades. The continuous air ventilation due exterior installation provides breathing of the buildings as well as protecting from excessive hot and cold weather conditions. PeliExterior is a natural insulation for the buildings.

PeliExterior, with particular surface application along with the special UV film at surface, has a maximum resistance against sunrays, rain, frost, dirt, dust and bacteria. PeliExterior EDS and PeliExterior EDF have successfully passed the tests as a requirement of EN 438-2/28 standards, thus proving their endurance against heavy weather conditions. PeliExterior EDS is a perfect solution for the exterior side covering against intensive weather conditions, where as PeliExterior EDF is a solution against fire resistance in addition to intense weather. PeliExterior production is in accordance with the EN 438-6 standards with the assurance of ISO 9001:2008. With its fortified structure against fire, PeliExterior has achieved

the maximum fire resistance classification of B s1 do / EGF in accordance with EN 13501-1. In addition, PeliExterior Compact Panels meet the safety, health and environmental criteria of the EN 438-7 standard with the conformity marking of AOC - level 3. If required, support and consultation can be given to state establishments and private companies for the correct and proper installation.

- ◆ Dirt-free and self cleaning.
- ◆ No deformation against instant climate changes between $-20^{\circ}\text{C}/+80^{\circ}\text{C}$
- ◆ Provides heat and sound (14 dB) insulation.
- ◆ Ensures breathing of building.
- ◆ Resistance against impact and solvents.
- ◆ Anti-reflective of sunrays due matt butte surface.
- ◆ Contains no hazardous materials (asbestos, severe metals, halogen, sulphur).

TEMPERATURE CHANGES IN SUMMER AND WINTER

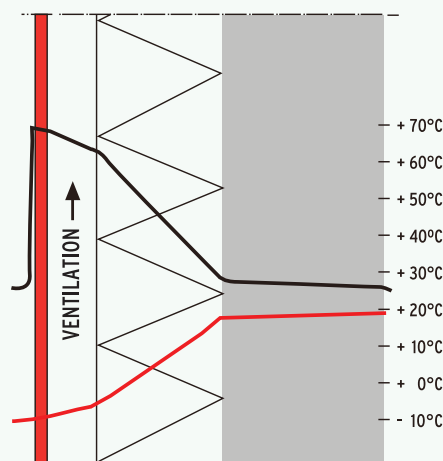

- Temperature Changes in Summer
- Temperature Changes in Winter

THE MOISTURE CHANGE ON PELIEXTERIOR

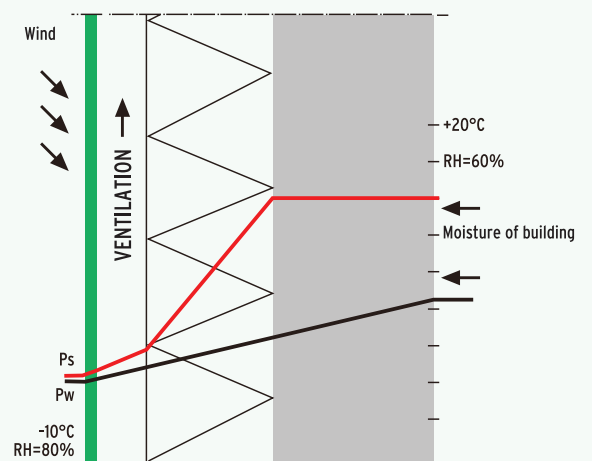

- Maximum Vapour Pressure
- Real Vapour Pressure / No Inner Concentration

PeliExterior[®] Compact

Ahşap sıcaklığını compact laminat ile birleştirerek bina cephelerini binanın ömrü ile eşitler. PeliExterior'un esnek yapısı ve yüksek darbe direnci binaların deprem güvenliği açısından diğer bütün uygulamalara karşı en büyük avantajıdır. Zengin desen ve renk çeşitliliği ile binaların cephesine özel görünüm kazandırır. Havalandırılmalı cephe sistemleri görüntü güzelliğinin yanı sıra binanın nefes almasını sağlar, düşük ısı iletkenliği ve yüksek ses yalıtım özelliği ekstra bir mantolama malzemesine ihtiyaç duymadan binalara doğal yalıtım sağlar. Yazın aşırı sıcaktan, kışın soğuktan koruduğu gibi dışarıdaki gürültüyü azaltarak sessizliği sağlar.

PeliExterior yüzeylerindeki özel UV filmle mevsimsel her türlü yağış ve güneş etkilerine azami dayanıklıdır. Bu alanda daha yoğun iklim şartlarına dayanıklı iki önemli ürünü üretirken, PeliExterior EDS ve PeliExterior EDF, her türlü talebe cevap vermektedir. PeliExterior EDS yoğun iklim şartlarının dış cephe kaplama ihtiyacını karşılarken, PeliExterior EDF ise yoğun iklim şartlarının ve yangına dayanım istenen yerlerin çözüm ürünüdür. PeliExterior üretimi ISO 9001:2008 güvencesi ile EN 438-6 standartına (dış mekan sınıfı sıkı lamine levhalar standardı) uygun olarak üretilmektedir. PeliExterior

yangına karşı güçlendirilmiş yapısıyla yangına tepki sınıflandırma testlerinden (EN 13501-1) başarıyla geçerek yanmaya karşı sınıfında en yüksek mukavemeti, B s1 do / EGF derecesi olarak göstermiştir. Ayrıca EN 438-7 standartının güvenlik, sağlık ve çevre gereklerini AOC - level 3 CE işaretlemesiyle karşılamaktadır. İstenildiği takdirde doğru uygulamanın yapılabilmesi için resmi kurumlara ve firmalara şartname desteği verilebilir.

- ◆ Güneş ışığı, yüksek nem, yağmur, toz fırtınası, kar ve dondan etkilenmez.
- ◆ -20 °C / +80°C arasında hızlı ısı değişimlerinde deformasyona uğramaz.
- ◆ Nano teknoloji yöntemiyle üretilen özel yüzeyi sayesinde mikrop barındırmaz.
- ◆ Anti-grafiti özelliği vardır.
- ◆ Kir tutmaz, kendi kendine temizlenir.
- ◆ Isı ve ses (14 dB) izolasyonu sağlar.
- ◆ Binanın nefes almasını sağlar.
- ◆ Darbeye karşı dayanıklıdır.
- ◆ Sağlığa zararlı maddeler içermez (asbest, ağır metal, halojen, sülfür).
- ◆ Yüzey şekli güneş ışınlarını yansıtmayan matbute yüzey ile üretilmektedir.

YAZ VE KIŞ AYLARINDAKİ SICAKLIK DEĞİŞİMİ

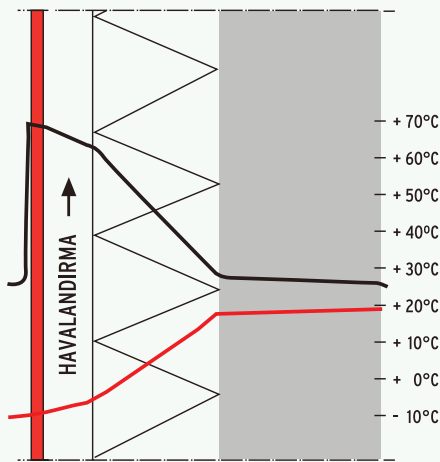

- Yaz Aylarındaki Sıcaklık Değişimi
- Kış Aylarındaki Sıcaklık Değişimi

DIŞ CEPHE ÜZERİNDEKİ NEM DEĞİŞİMİ

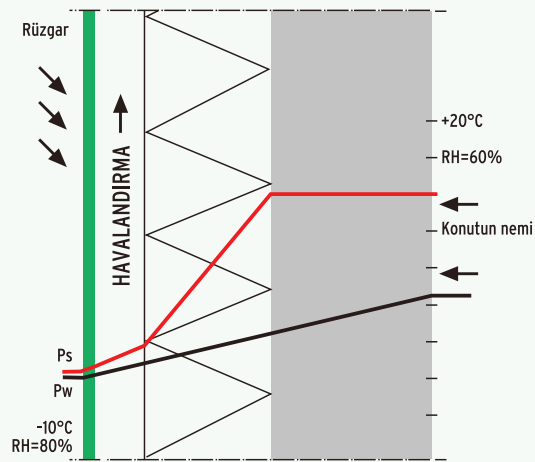

- Maksimum Buhar Baskısı
- Gerçek Buhar Baskısı /
- $P_s > P_w =$ İç Yoğunlaşma Yok

HANDLING AND STORAGE

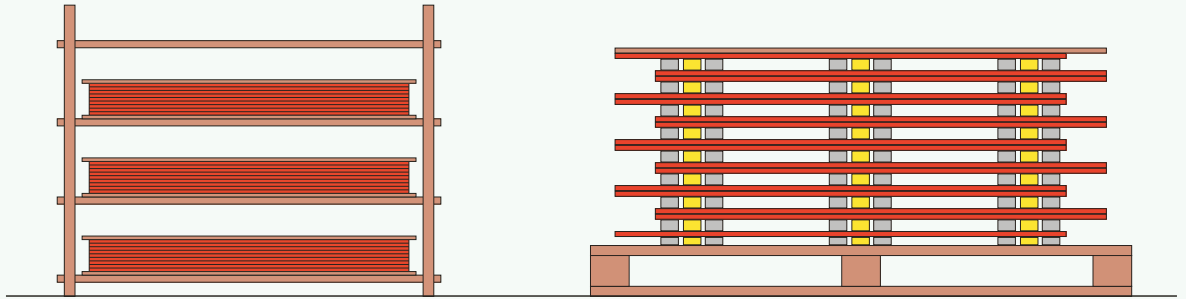

PeliExterior panels are stocked and laid HORIZONTALLY on top of pallets on a flat surface. No stacking to walls and no vertical placement. All compact panels have protective folio film on the top surface. The protective film should not be removed until the application and installation is finished. Panels should be handled, carried and transported with the protective film on until all mounting work is completed. Panels with protective film should not be exposed to direct

sunlight and heat for an extended period of time. Panels must be LIFTED, not pulled or pushed from the edges while loading and handling. The EXTERIOR compact panels should be stored in closed rooms under dry, normal climatic conditions. For climate disparity, panels must remain for 24 hours under new climate condition. With pre-installed fastening elements, care should be taken as to the climate effect is uniform on all sides.



TAŞIMA VE SAKLAMA

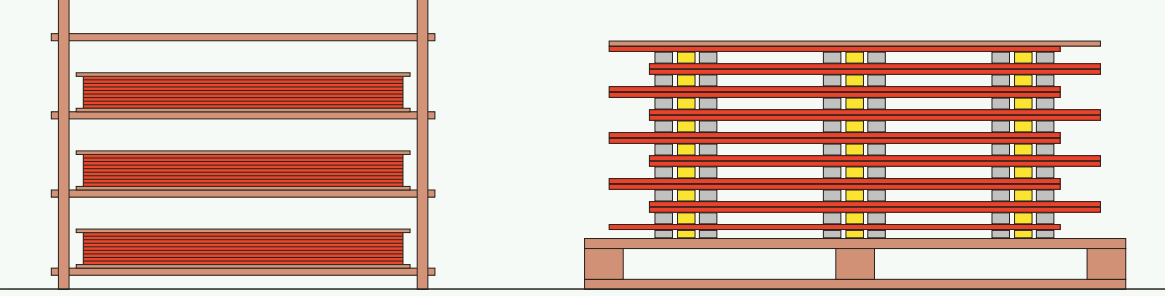

Peliexterior, düz bir yüzey üzerinde paletler üstünde yatay olarak stoklanmalıdır. Üretimde veya şantiyelerde duvarlara yaslanmamalı ve dikey olarak stoklanmamalıdır. Tüm kompakt laminatların yüzeyinde koruyucu folyo mevcuttur. Plakalar yerine monte edilip tüm işlemler bitene kadar hem taşıma, hem de montaj esnasında yüzeydeki koruyucu folyo çıkarılmamalıdır. Plakalar, üzerindeki koruyucu folyo ile uzun süre direk güneş ışınlarına ve yüksek ısıya

maruz kalmamalıdır. Yükleme, depolama ve transfer esnasında plakalar birbirleri üzerinden kaydırılmamalı ve mutlaka kaldırılarak taşınmalıdır. Peliexterior, üzeri kapalı depolarda kuru ve normal iklim şartlarında muhafaza edilmelidir. İklim ve ısı farklılıklarından etkilenmemesi için, montaj öncesi yeni iklim ortamında 24 saat bekletilmelidir. Isı ve iklim farkı etkilerinin plakaların her tarafında aynı olmasına dikkat edilmelidir.



CUTTING AND CLEANING

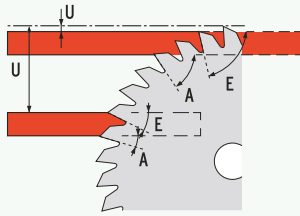

In order to cut the top surface properly, lift the plate up to the top.

E= Entry Angle
A= Exit Angle

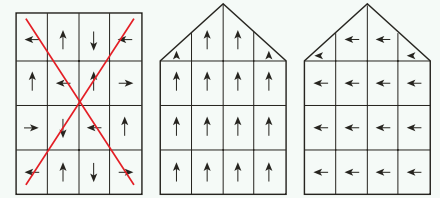
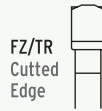

Panels are cut and milled by ordinary horizontal milling machines with carbide-tipped round saw blades. Special care must be taken for the 1/2 proportion between the width and the length when calculating the cutting dimensions of the compact exterior panels. To avoid color tone variations on the surface at reflection of light, cutting must be applied at similar direction for both width and the length. PeliExterior panels need no special care. Cleaning is necessary under

special circumstances such as accumulation of dirt during the application. In such cases, wipe away the dirt with clean warm water using cloth or rag and soap. NEVER use cleaning powder or other chemical liquids containing solvents. DO NOT scrap with hard objects.



EBATLAMA VE TEMİZLEME

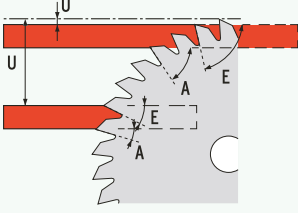

Üst yüzeyi düzgün kesmek için tepsiyi olabildiğince yükseğe kaldırın.

E= Giriş Açısı
A= Çıkış Açısı

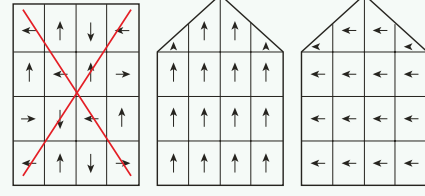

Plakalar bilinen marangoz makineleri ile kesilir ve frezelenir. Bu amaçla güçlü el aletleri de kullanılabilir. Tepsi özellikleri: Daire testerelede elmas diş veya dia dişler (daha uzun ömür için kullanılmalıdır. 25 cm çap, 64 diş trapezoidal diş (FZ/TR), 4000 devir en iyi sonuç için kullanılmalıdır) Dış cephe compact laminat plakalarının kesim ölçüleri hazırlanırken en ile boy arasında 1/2 oranı olmasına dikkat edilmelidir. (Plakanın orijinal ölçüleri gibi suyuna yönü uzun, sokrası kısa olmalı)

Plakaların kesimi sırasında en ve boyları hep aynı yönde kullanılmalıdır. Işık yansımaları farklı olabileceğinden ton farkları oluşabilmektedir. Plakalar özel bakım gerektirmeyen bir üründür. Uygulama sırasında oluşan kirleri ılık suyla yıkayınız. Asla ovucu tiner, solvent bazlı kimyasallar kullanmayınız, sert cisimler ile kazımayınız.



GUIDELINE FOR APPLICATIONS

AIR CIRCULATION

An efficient air circulation must be secured between PeliExterior and the surface or the coating of the building. The blank grouting spaces allowed for ventilation between the panels should not be filled with any material. An efficient air circulation must be provided from the ground level of the exterior panel to the top edge. A minimum of 50 cm² space is required for every 1 m width. If no air ventilation gap is reserved at the construction framework, deformation will occur on the exterior panels.

EXPANSION SPACES

The dimensions of exterior compact panels are changeable due rate of moisture at weather. In humid weather conditions, the panels enlarge whereas shrinkage occurs in dry conditions, The humidity and heat do not always change in the same direction; opposite movements may occur. Therefore leaving expansion spaces between the panels is an absolute requirement. The diameters of mouthpieces drilled for screws, bolts and rivets must be 2-3 mm larger than the diameters of the screws. At hidden screw systems, spaces must be on the construction framework. There must be no silicone use at grouting process.

JOINTS

The glue mastic should be applied maximum 2 cm from the edge in continuity; and maximum 5 cm from the edges at screw installations. Rivet and screw distance must be minimum 20 mm in-between and for hidden screw and hang systems, the distance between screws must be at least 80 mm.

FRAMEWORK PARTITION SPACE

The partition space depends on panel thickness. For 6 mm thickness, the vertical framework space should be maximum 550 mm. The windload should be calculated according to the location and the height of the application. If necessary, additional supportive elements must be utilized at the center-back of the plates. Detailed information can be found at the section of "Application Methods".

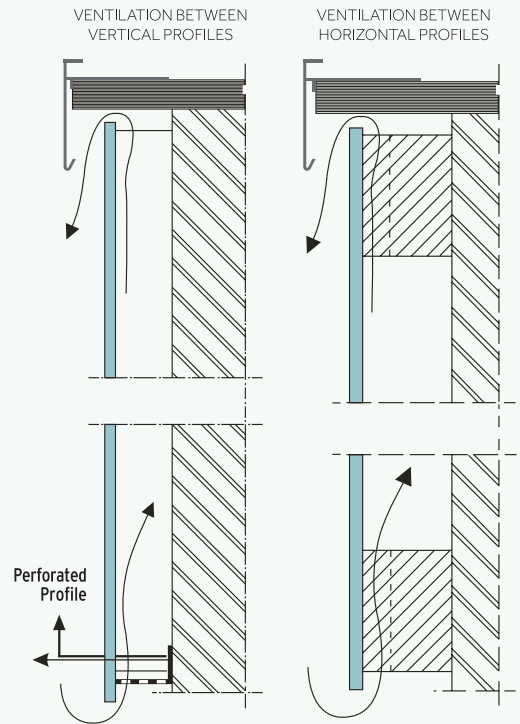

This standard, applies to Exterior-grade Compact laminates of thickness 2 mm and greater. It specifies requirements for standard and flame-retardant laminates intended for use under outdoor weather conditions such as direct sunlight rain and frost. Two levels of performance are specified; one for moderate exterior conditions, and the other for severe exterior conditions, Laminates complying with this Part of EN 438 are referred to as Exterior-grade Compact laminates, and are characterized by their high tensile strength, high impact resistance, thermal shock resistance, and resistance to weather and corrosion. They are available in a variety of decorative colors, with high resistance to color change and aging in outdoor applications. When they are self-supporting Exterior-grade Compact laminates are ready for installation, and only require cutting to size, drilling, etc. to suit the application. EN 438-2 specifies the methods of test relevant to this part of EN 438.

UYGULAMADA DİKKAT EDİLMESİ GEREKENLER

HAVA SİRKÜLASYONU

Bina yüzeyi veya mantolama ile Peliexterior arasında iyi bir hava sirkülasyonu sağlanmalıdır. Bu amaçla plakaların çevresinde bırakılan derz boşlukları herhangi bir malzeme ile doldurulmamalıdır. Cephelerin zeminde başladığı yerden üst bitiş noktasına kadar sağlıklı hava akımı sağlanmalıdır. Yapılan konstrüksiyonda hava boşluğu bırakılmadığı takdirde plakalarda deformasyon oluşur.

GENLEŞME BOŞLUKLARI

Dış cephe compact laminatları havanın nemine ve sıcaklığına bağlı olarak boyut değiştirir. Bu durumda plaka boyutu daralır veya genişir. Metal konstrüksiyonlar sıcaklığa bağlı olarak boyut değiştirir. Havanın nemi ile sıcaklığı her zaman aynı yönde değişmez bazen ters yönde gelişir. Bu nedenle genleşme boşlukları çok önemlidir. Plakalar arasında genleşme amacıyla boşluk bırakılmak zorunludur. Aynı şekilde perçin veya vida için açılan delikler perçin veya vidadan 2-3 mm daha büyük açılmalı, gizli vidalama sisteminde boşluklar konstrüksiyon üzerinde bırakılmalıdır. Derz boşluklarında silikon kullanılmamalıdır.

BAĞLANTI YERLERİ

Yapıştırırmada kullanılan mastik kenardan en çok 2 cm içinden ve aralıksız olarak sürülmeli. Vidalama sisteminde ise en çok 5 cm içerden uygulanmalıdır. Perçin ve vida aralıkları en yakın 20 mm, gizli vidalama ve askı sistemlerinde ise en yakın 80 mm olmalıdır.

KONSTRÜKSİYON ARA BOŞLUKLARI

Konstrüksiyon ara boşlukları kullanılacak compact laminat kalınlığına bağlıdır. 6 mm için düşey konstrüksiyon araları en çok 550 mm olmalıdır. Uygulama yapılacak bölge ve yüksekliğe göre Rüzgar Yükü mutlaka hesaplanmalı ve gerekirse plakaların ortalarına arkadan destek yapılmalıdır. Konularla ilgili ayrıntılı bilgi ve ölçüler uygulama yöntemlerinde anlatılacaktır.

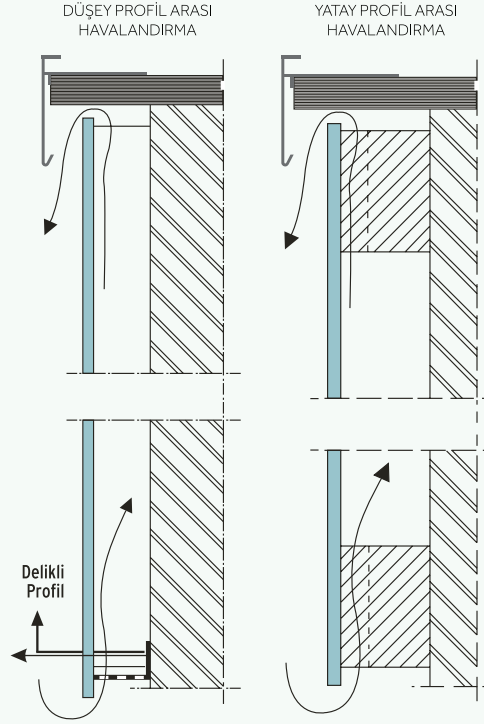

Bu standart, 2 mm. ve daha kalın olan dış mekan sınıfı sıkı lamine levhaları kapsar. Bu standart, doğrudan güneş ışığına maruz kalma, yağmur ve don gibi dış mekan iklim şartlarında kullanılmak üzere tasarlanmış standart sınıf veya yangın geciktiricili sınıf lamine levhalar için gerekleri kapsar. İki performans seviyesi belirtilmiştir; birincisi normal dış mekan iklim şartları için, ikincisi şiddetli dış mekan iklim şartları için. Bu standarta uygunluk gösteren lamineler dış mekan sınıfı sıkı lamine levhalar olarak adlandırılırlar ve bu levhalar, yüksek çekme mukavemeti, yüksek çarpma mukavemeti, ısı şoku mukavemeti ve iklime ve küflenmeye mukavemet özellikleri ile karakterize edilmişlerdir. Dış mekan sınıfı lamine levhalar, renk değişimine ve dış mekan kullanımlarında eskimeye yüksek mukavemeti olan çok değişik dekoratif renkler de mevcuttur. Dış mekan sınıfı sıkı lamineler kendini taşıyan nitelikte olduklarından döşeme için hazırdırlar ve uygulama yerini uygun hale getirmek için yalnızca ölçülere kesilmeleri ve delinmeleri gibi işlemlerin yapılması gerekir. EN 438-2, EN 438 standart serisinin bu bölümü ile ilgili deney metotlarını kapsar.

APPLICATION SYSTEMS / UYGULAMA SİSTEMLERİ

ADHESIVE (GLUE) SYSTEMS

The adhesive mastic manufacturers guarantee their products up to 18 meters height at exterior compact panel applications for usually 6mm thick panels. The temperature should be between 5-35°C. Glue mastics should not be used over 75% humidity or rainy conditions. The adhesion will be weak if the surface temperature on the framework as well as the exterior panel exceeds 35°C. During gluing process, both surfaces should be well cleaned, sanded and carefully pretreated. Manufacturer's recommendations should be followed. The use of aluminum profile is recommended for the construction. Aluminum and galvanized profiles should be sanded thoroughly. The space between the vertical profiles during the framework preparation depends on the thickness of the compact panel.

YAPIŞTIRMA SİSTEMLERİ

Yapıştırma mastiği üreten firmalar dış cephe compact laminat uygulamalarına 18m yüksekliğe kadar garanti vermektedirler. Bu yöntemde genellikle 6mm kalınlık kullanılmaktadır. Sistemin uygulanacağı ortam sıcaklığı 5-35°C arasında olmalıdır, %75 üzerindeki nem oranında ve yağmurlu havalarda yapıştırma sistemi uygulanmamalıdır. Konstrüksiyon ve plakaların yüzey sıcaklığı 35°C üstünde olması halinde yapıştırma zayıf olacaktır. Yapıştırma yönteminde her iki yüzeyin iyi temizlenmesi, zımparalanması ve primer tatbikinin dikkatli yapılması gerekir. Üreticinin tavsiyelerine dikkat edilmelidir Konstrüksiyon olarak alüminyum profil kullanılması tavsiye edilir. Konstrüksiyon hazırlanması sırasında düşey konulan profillerin arasındaki boşluk compact laminatın kalınlığına göre değişir.

Panel thickness Panel kalınlığı	Gluing on two profiles İki profil üstüne yapışma	Gluing on more than two profiles İkiden fazla profile yapışma
6mm	450mm	550mm (a)
8-10mm	600mm	750mm (a)

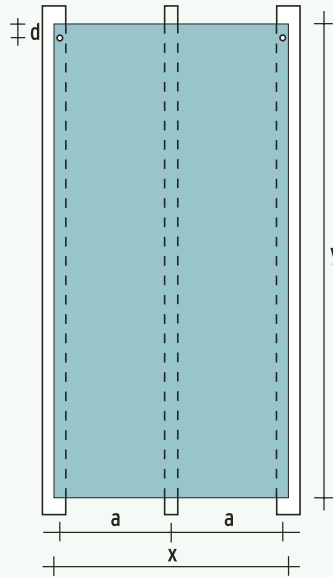
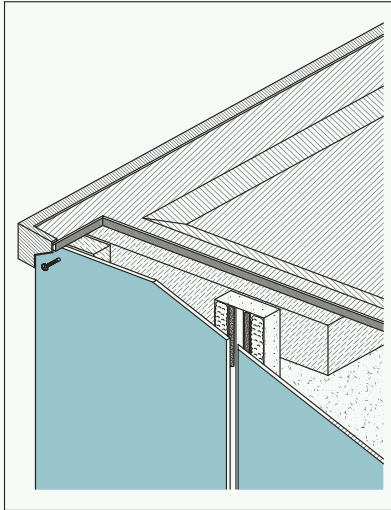

RIVET AND SCREW SYSTEM

For 6 mm to 10 mm panels of Peliexterior, rivet and screw system is suitable. This system is also used for supporting the adhesive systems on high-rise buildings to increase the security. Joint spaces and vertical profile spaces are similar with the adhesive system. Open joint, halvet joint and male-female joints are usually used at joint spaces. The mouthpiece drilling on the center of panel is opened with the same diameter as the rivet. Other holes are opened 3mm wider than the rivet and screw diameters, thus enabling movement of plates in case of expansion. The placement of the holes should be minimum 20mm distance from the panel edge and distance maximum 10 times of the plate thickness.

PERÇİNLİ VE VİDALI SİSTEM

Peliexterior'un 6, 8 ve 10mm kalınlıkları perçinli ve üstten vidalı sistemler için uygundur. Yüksek binalarda uygulandığı gibi yapıştırma sistemi ile birlikte güvenliği arttırmak amacıyla da kullanılır. Derz boşlukları ve düşey profil aralıkları yapıştırma yöntemindeki ile aynıdır. Derz boşluklarında açık derz, lamba - zıvanalı derz ve erkekdişi modeller kullanılır. Perçinli ve vidalı sistemlerde plakanın ortasına gelen delik perçin çapı ile aynı çapta açılır, ilk bağlantı buradan yapılır. Diğer delikler perçin veya vida çapından 3mm daha büyük açılır, bu şekilde plakanın genleşmesi sırasında hareket etmesi sağlanır. Deliklerin plaka kenarına olan mesafesi en az 20mm, en çok plaka kalınlığının 10 katı olabilir.

Thickness of sheets Plaka kalınlığı	6mm	8mm	10mm
Distance of holes to edge Deliklerin kenara uzaklığı (b)	20-60mm	20-80mm	20-200mm
Maximum horizontal distance between the holes Delikler arası yatay aralık(en çok) (a)	450mm	600mm	750mm
Maximum vertical distance between the holes Delikler arası düşey aralık(en çok) (c)	550mm	750mm	900mm

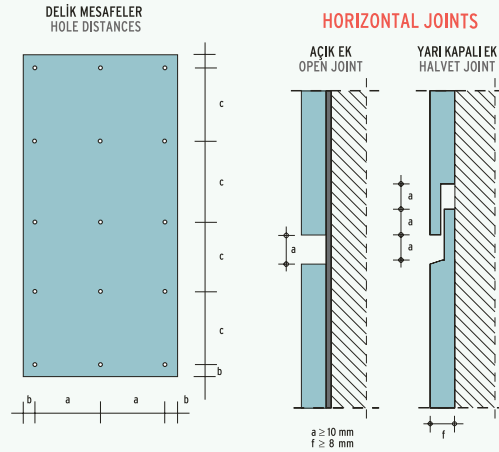

**HOLE SPACE
DELİK BOŞLUĞU**

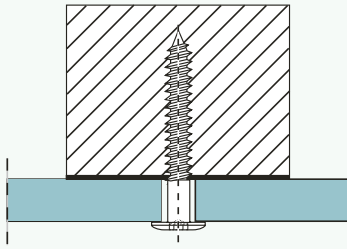

**VERTICAL JOINTS
DİKEY EK YERLERİ
TONGUED AND GROOVED
ÇİTALIK EK YERİ JOINT**

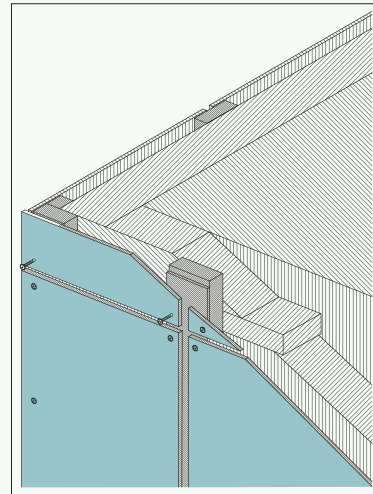
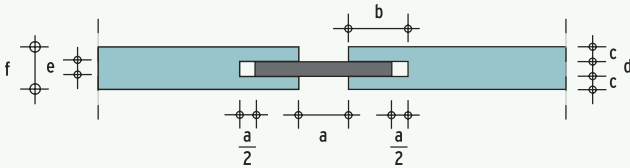

APPLICATION SYSTEMS / UYGULAMA SİSTEMLERİ

SUSPENSION (HANGING) SYSTEM WITH HIDDEN FIXING

This system is suitable for PeliExterior panels of 8, 10 and 13mm thickness. Suspension components are screwed from the back of panel, therefore invisible from the front side. This system is the most secure application for the high-rise buildings, enabling easy adjustment of the panel during installation however the most costly method in terms of accessories and labour.

ASKI SİSTEMİ

PeliExterior'un 8, 10 ve 13mm kalınlıkları için uygundur. Askı elemanları plakalara arka yüzden vidalanır (gömme özel dübelleri kullanılır). Bu nedenle ön yüzeyde vida başları görünmez. Bu sistem yüksek binalarda uygulanacak en güvenli model olup montajı sırasında plakaların ayarı çok daha kolay yapılır. Aksesuar ve işçilik yönünden en pahalı uygulama şeklidir.

Thickness of sheets Plaka kalınlığı	8mm	10mm	13mm
Distance of holes to edge Deliklerin kenara uzaklığı (b)	80-80mm	80-100mm	80-130mm
Maximum horizontal distance between the holes Delikler arası yatay aralık(en çok) (a)	650mm	750mm	900mm
Maximum vertical distance between the holes Delikler arası düşey aralık(en çok) (c)	750mm	900mm	1200mm

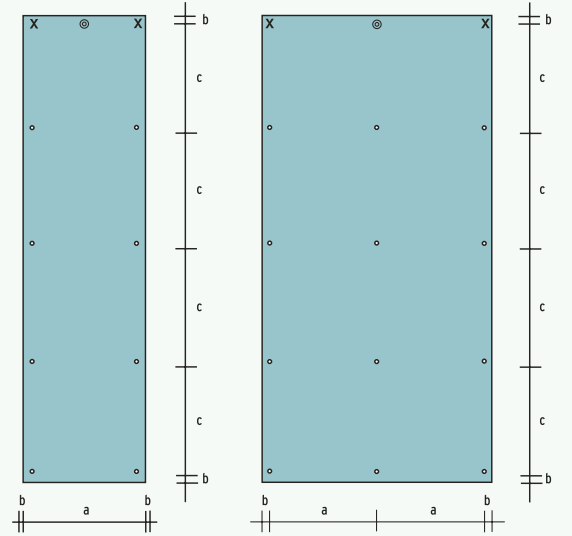
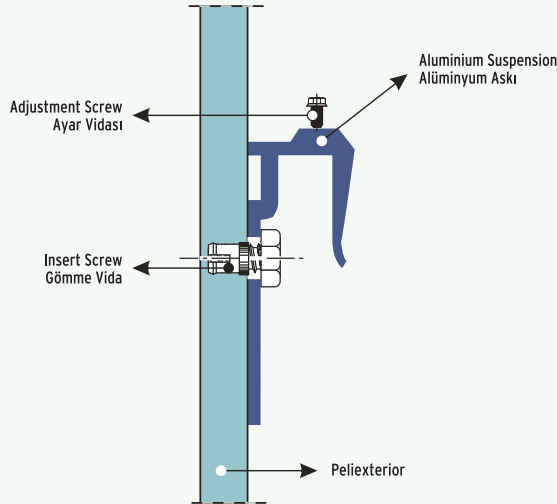
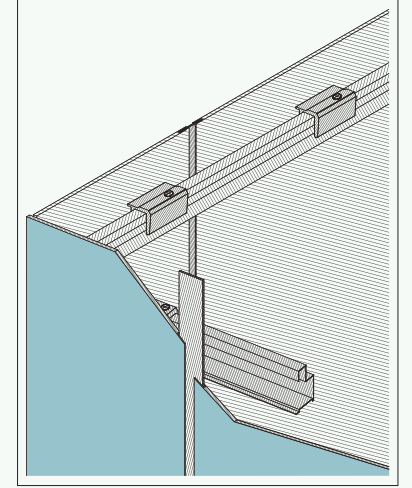

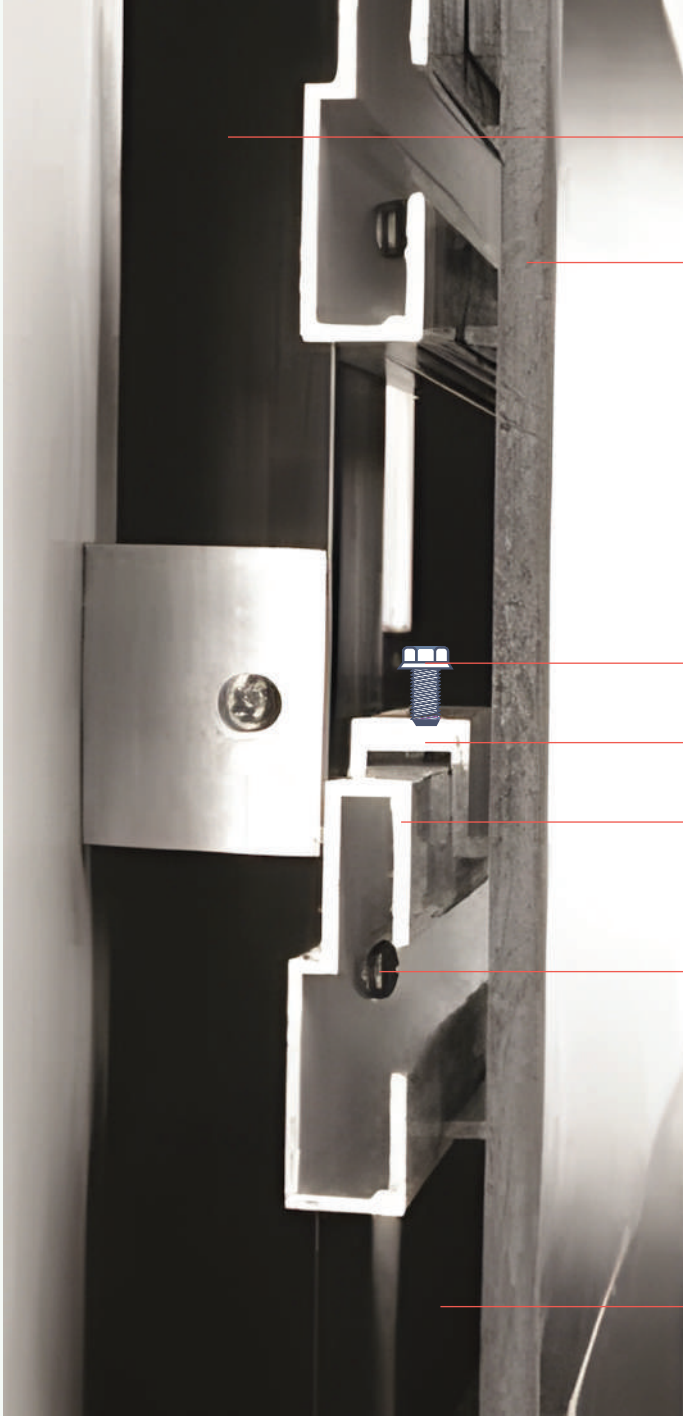

Vertical Profile
Düsey Profil

Peliexterior

Adjustment Screw
Ayar Vidası

Aluminium Suspension
Alüminyum Askı

Aluminium Guide
Alüminyum Ray

Fixing Screw
Bağlantı Vidası

Gap
Boşluk

APPLICATION SYSTEMS / UYGULAMA SİSTEMLERİ

SIDING-BLIND FIXING WITH CLIPS

Siding is suitable for PeliExterior 6, 8 and 10 mm panel thicknesses. This system is preferred for the traditional woodwork look. The plates are cut at 200 - 300 mm widths for the application. The distance between the agraffes should not exceed 500 mm and all agraffes and screws must be stainless steel.

YALI BASKI SİSTEMİ

PeliExterior'un 6, 8 ve 10 mm kalınlıkları için uygundur. Eski ahşap kaplamalara benzeyen nostaljik görüntüsüyle tercih edilen bir yöntemdir. Plakalar 200 - 300 mm genişliğinde kesilerek uygulanır. Agrafalar arası 500 mm geçmemeli, kullanılacak tüm vida ve agrafalar paslanmaz çelik olmalıdır.

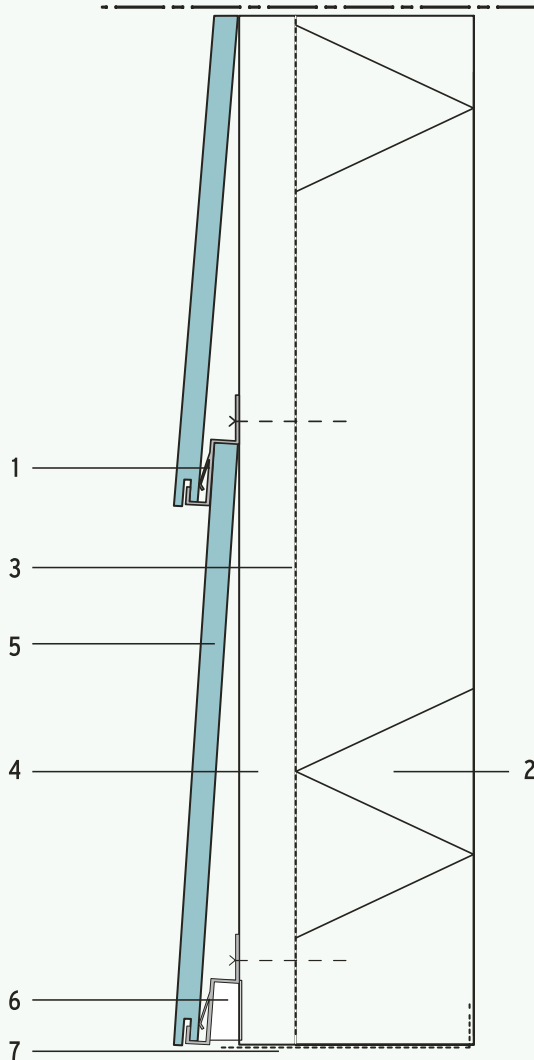

- 1 Stainless steel agraffe
Paslanmaz çelik agraf
- 2 Isolation
İsı yalıtımı
- 3 Protective foil
Koruyucu folyo
- 4 Ventilation space
Havalandırma boşluğu
- 5 PeliExterior 6, 8, 10 mm
PeliExterior 6, 8, 10 mm
- 6 Distance adjustment profile 6, 8, 10 mm
Kalınlık ayarlama çantası 6, 8, 10 mm
- 7 Ventilation profile
Havalandırma profili





PeliDigi®

Do not limit your imagination!

The digital printed exterior panels are offering endless creations, bringing your imaginations to life.

Hayallerinizi Sınırlamayın!

PeliLam'ın üstün yüzey direnci ve malzeme kalitesiyle bütünleşen PeliDigi, yaratıcı projeler ve uygulamalar için tasarımların sonsuzluğunu sizlerle paylaşıyor. Farklı yüzey dokuları sayesinde, yarattığı doku hassasiyetiyle de sektördeki ürünlerden kendini ayırıyor.









One Design On All Types Of Different Panels

Değişik Tip Panellerde Aynı Desen Uygulaması

1 - MDF Ultra Gloss UV Lacquered Panel / MDF Ultra Parlak UV Laklı Panel **2 - Chipboard Ultra Mat UV Lacquered Panel / Sunta Ultra Mat UV Laklı Panel** **3 - MDF Ultra Mat UV Lacquered Panel / MDF Ultra Mat UV Laklı Panel** **4 - MDF Panel / MDF Lam Panel** **5 - Chipboard Ultra Gloss UV Lacquered Panel / Sunta Ultra Parlak UV Laklı Panel** **6 - Chipboard Ultra Gloss UV Lacquered Panel / Sunta Ultra Parlak UV Laklı Panel** **7 - MDF Ultra Gloss UV Lacquered Panel / MDF Ultra Parlak UV Laklı Panel** **8 - MF Chipboard Panel / Sunta Lam Panel** **9 - HPL Comvcompact Laminate Table Tops / HPL Kompakt Laminat Masa Tablası** **10 - MDF Ultra Gloss UV Lacquered Table Tops With ABS Metal Face Edge Banding / MDF Ultra Parlak UV Laklı Panel Masa Tablası, Metal Görünümlü Pvc Kenar Bantlı** **11 - HPL Laminate Faced Plywoods / HPL Laminat Kaplı Kontrplak** **12 - CPL 0,20 mm Micro Laminate - HPL CPL Laminate - HPL CPL Laminate / CPL 0,20 mm Mikro Laminat - HPL CPL Laminat** **13 - HPL/CPL Laminate / HPL/CPL Laminat** **14 - HPL Exterior Compact Laminate / HPL Dış Cephe Kompakt Laminat** **15 - HPL Compact Laminate / HPL Kompakt Laminat** **16 - HPL Lab Compact Laminate / HPL Laboratuvar Kompakt Laminat**

Digital Solutions / Dijital Dekor Çözümler

Conventional Decor / Konvansiyonel Dekor

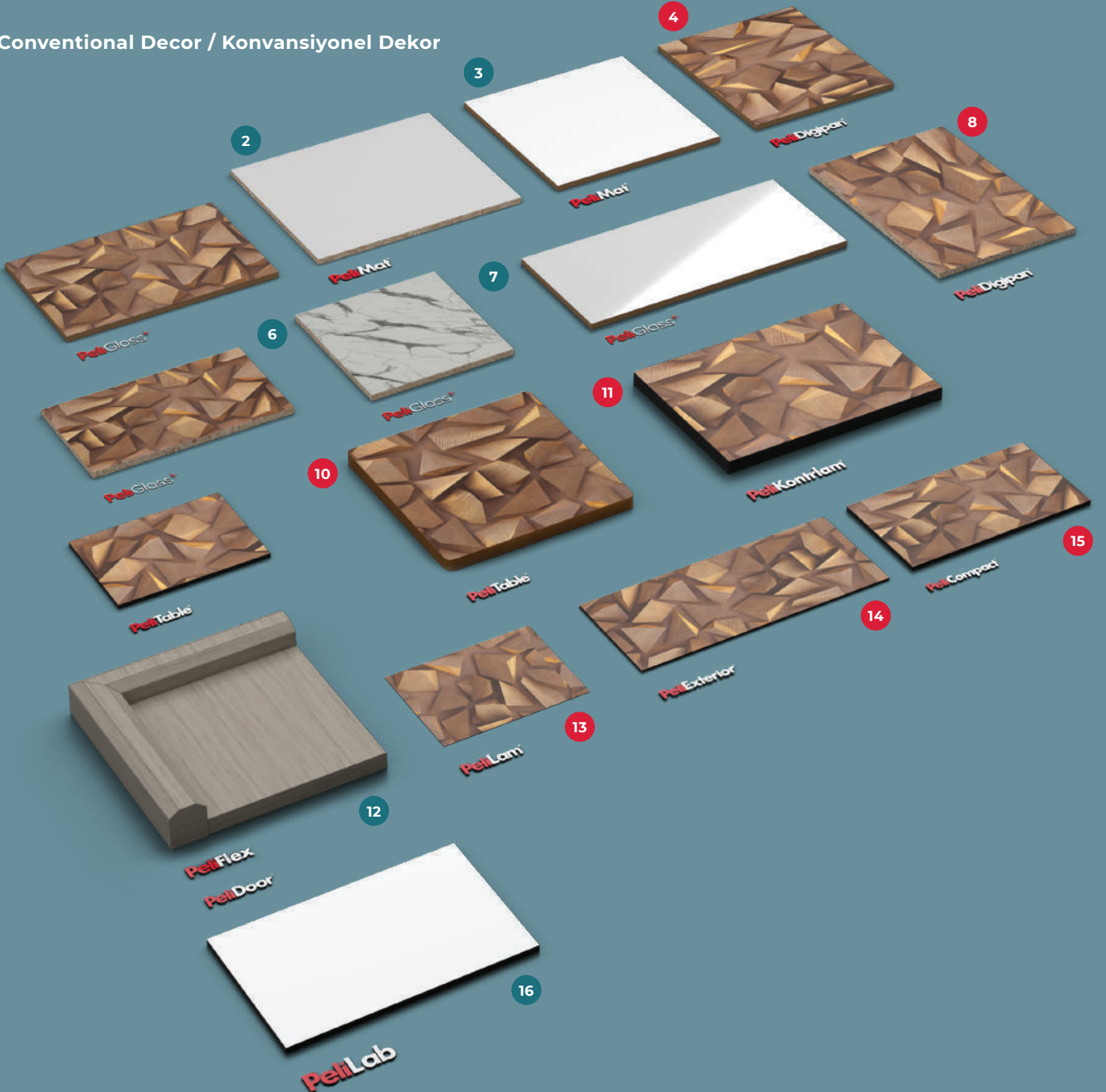







PeliExterior[®]
Compact

References
Referanslar



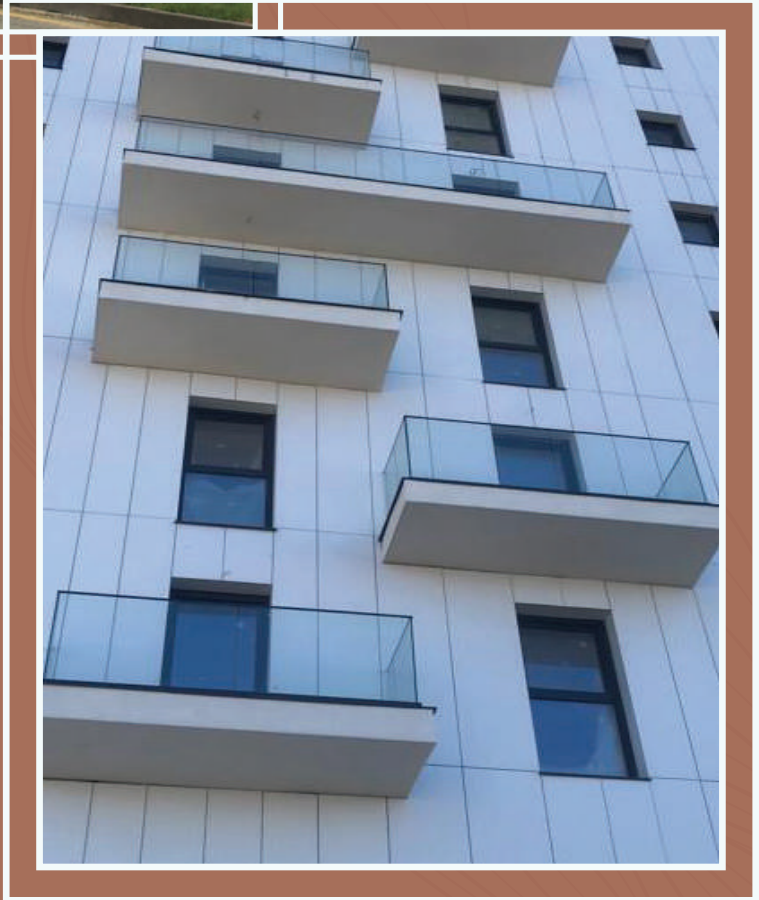

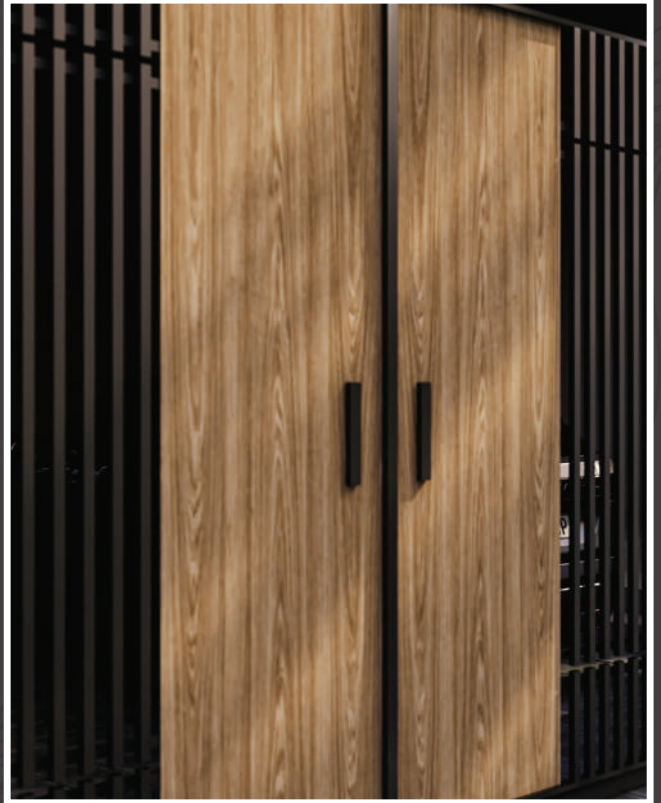
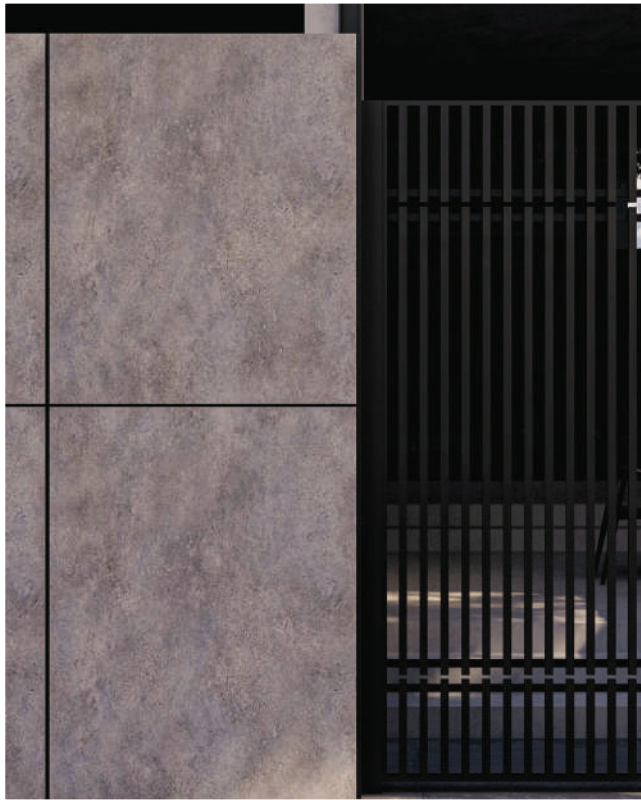





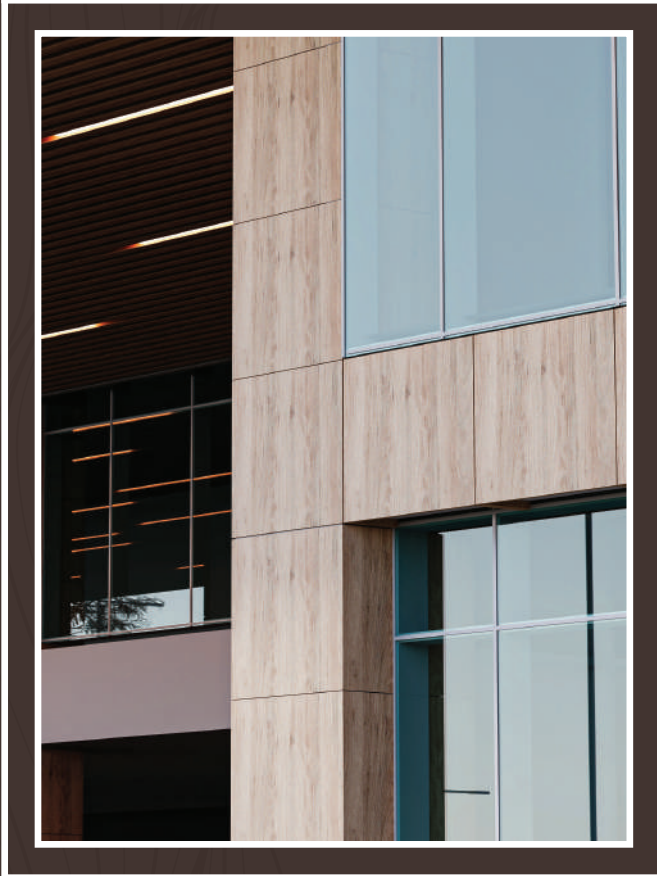
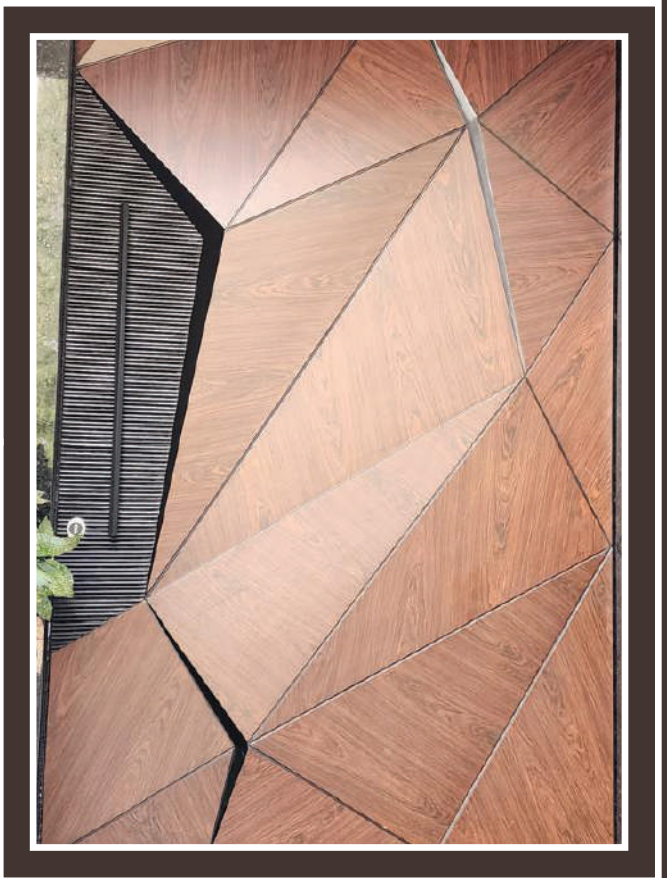

Peli®

Head Office / Merkez Ofis

Halkalı Cad. No: 170 34295
Sefaköy - İstanbul / Türkiye
T: +90 212 698 89 92
F: +90 212 698 89 95



peliglobal.com
pelicompact.com



ISO 9001:2015



TS EN 438-3



FSC



Fraunhofer